



# DOUBLE CONTAINMENT DESIGN & INSTALLATION GUIDE

DC-3-0817

The information contained in this publication is based on current information and product design at the time of publication and is subject to change without notification. Our ongoing commitment to product improvement may result in some variation. No representations, guarantees or warranties of any kind are made as to its accuracy, suitability for particular applications or results to be obtained therefrom. For verification of technical data or additional information not contained herein, please contact Spears® Technical Services Department [West Coast: (818) 364-1611 - East Coast - (678) 985-1263].

Spears® Double Containment Systems are engineered for ease of installation and lower associated installation costs. Complete systems include all necessary components - carrier pipe, containment pipe, centralizer brackets, valves and valve boxes, plus a full assortment of simplified double containment configurations including elbows, tees, closure and termination fittings. Typical user-supplied components include leak detection cable and sensors, air relief valves, and solvent cement for assembly.

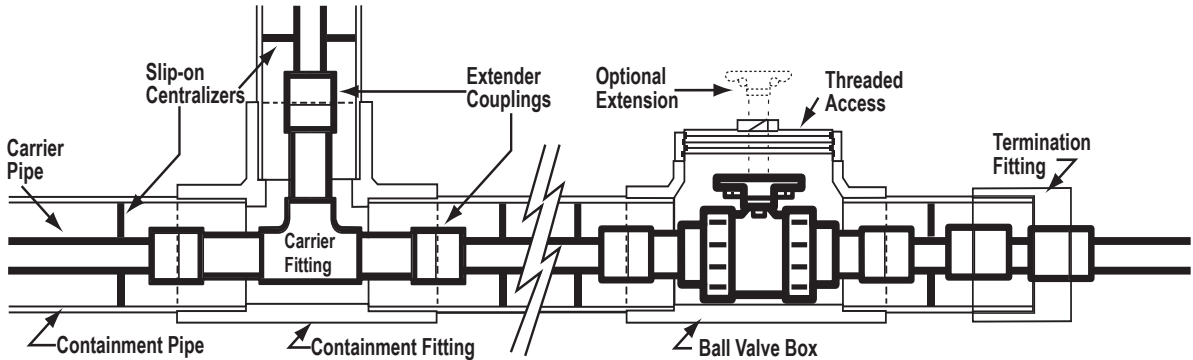

Successful installation requires proper design and planning of system layout, a basic understanding of how Spears® double containment fitting design works, and specific attention to a proper sequence of general assembly. This manual is designed as a general guide and may not address all situations encountered. Due to the variety of selected Carrier/Containment combinations some design variations may occur.

Unlike other Double Containment systems, the Spears® Double Containment System offers the user a variety of material choices and size combinations. The Spears® Double Containment System can be characterized as actually combining two separate thermoplastic systems of different sizes with similar or identical pressures. Because of our diverse offering, consideration must be given to properly matching the system design pressure ratings of the carrier (inner) pipe and containment (outer) pipe.

**PLEASE READ ALL INSTRUCTIONS PRIOR TO SYSTEM ASSEMBLY**

**CONTENTS**

<i>Introduction &amp; Contents</i> .....	1
<i>I. SYSTEM PLANNING &amp; LAYOUT</i> .....	2
<i>II. DOUBLE CONTAINMENT FITTING &amp; COMPONENT DESIGN OVERVIEW</i> .....	3
<i>III. PRODUCT RECEIVED</i> .....	4
<i>IV. GENERAL INSTALLATION ASSEMBLY</i> .....	5
<i>V. SPECIAL CLOSURE FITTING INSTALLATION</i> .....	8
<i>VI. ISOLATION COUPLER INSTALLATION</i> .....	12
<i>VII. IN-LINE VALVE BOX INSTALLATION</i> .....	13
<i>VIII. EXPANSION JOINT INSTALLATION</i> .....	13
<i>IX. SENSOR SADDLE INSTALLATION</i> .....	15
<i>X. PRESSURE TESTING SYSTEM</i> .....	15
<i>Appendix A: General Solvent Cement Welding Procedures</i> .....	16
<i>Appendix B: Sample Engineering Specification</i> .....	17

**NOT FOR DISTRIBUTION OF COMPRESSED AIR OR GAS.**



# DOUBLE CONTAINMENT DESIGN & INSTALLATION GUIDE

## I. SYSTEM PLANNING & LAYOUT

The system designer is responsible for assuring that the containment piping is not over-pressurized should a leak occur from the carrier pipe. This is accomplished by choosing a containment pipe pressure rating that meets or exceeds the carrier pipe system design pressure. For example: If the carrier pipe is required to withstand 50 psi @73°F. system design pressure, the containment pipe chosen must be rated to at least 50 psi. Proper matching will ensure that the containment pipe can adequately contain a leak until a repair can be made.

- **Carrier/Containment Combinations:** System primary carrier and secondary containment size, and material and pipe Schedule must be determined based on system temperature, pressure, and volume requirements. Standard Carrier x Containment sizes and material/Schedule combinations are shown in the table below. Double containment systems can be custom produced to virtually any standard pipe size, material, or material combinations not shown, including multiple carriers in a single containment system. Contact Spears® Technical Services.

### STANDARD CARRIER X CONTAINMENT COMBINATIONS

Carrier x Containment Size	PVC Sch 40 x PVC Sch 40	PVC Sch 40 x PVC Sch 40 Clear	PVC Sch 80 x PVC Sch 40	PVC Sch 80 x PVC Sch 40 Clear	PVC Sch 80 x PVC Sch 80	CPVC Sch 80 x PVC Sch 40	CPVC Sch 80 x CPVC Sch 80	CPVC Sch 80 x PVC Sch 40
1/2 x 2	•	•	•	•	•	•	•	•
3/4 x 3	•	•	•	•	•	•	•	•
1 x 3	•	•	•	•	•	•	•	•
1-1/2 x 4	•	•	•	•	•	•	•	•
2 x 4	•	•	•	•	•	•	•	•
3 x 6	•	•	•	•	•	•	•	•
4 x 8	•	•	•	•	•	•	•	•
6 x 10	•	N/A	•	N/A	•	•	•	N/A
8 x 12	•	N/A	•	N/A	•	•	•	N/A

N/A = Not available in specified size and material

**System Support:** The system must be supported according to standard pipe support methods and criteria for installation of the Containment-size pipe. Where practical, system support should align with internal carrier support (centralizers) to reduce concentrated point loads.

- **Caution:** System must be designed so that if carrier fails (leaks), the Containment pipe must not be pressurized beyond 10 psi pressure. An extremely hazardous condition can result from the air in the containment pipe becoming compressed. An air relief valve can be used or a vent to a containment vessel can be installed.
- **Thermal Expansion & Contraction:** Both Containment and Carrier system expansion and contraction must be determined, just like any other system. This is especially important where significantly different fluid temperatures are anticipated between the Carrier system and the Containment system. The primary line must be designed to allow for expansion & contraction due to process media temperature. The secondary line must be designed to accommodate temperature changes, especially in above ground installation where environmental factors will affect the temperature of the pipe.
- **Containment Thrust Blocking:** Adequate thrust blocking must be determined for the system and related loads.
- **Termination Points:** Must be determined for both start and end of Containment portion of the system.
- **Leak Detection Sensors, Drains, Valve Box, etc.:** Location and type must be determined (i.e. ball valve, gate valve, etc.)

# DOUBLE CONTAINMENT DESIGN & INSTALLATION GUIDE



## II. DOUBLE CONTAINMENT FITTING & COMPONENT DESIGN OVERVIEW

A basic understanding of Spears® double containment fitting and component design will make assembly much easier. Additional details of their application is found in each specific installation section.

- General configurations (elbows, tees, etc.) of Spears® double containment fittings consist of separate internal Carrier and external Containment fittings of the same configuration. Carrier fittings (except standard couplings) are equipped with extenders to facilitate cement assembly. Centralizers are used inside the Containment piping system, but not inside fittings in order to: 1) allow movement of the Carrier assembly inside the Containment system during expansion and contraction; and 2) allow the Carrier assembly to be more easily cemented before cementing the Containment assembly.

**NOTE:** Certain configurations may require oversized containment fittings bushed to specified containment pipe size in order to accommodate specified carrier fitting configurations.

- Most double containment fitting configurations (where practical) are designed with dimensions that bring the pipe stop of the Carrier fitting flush to the face of the socket of the Containment fitting. This facilitates solvent cementing and determination of Carrier and Containment pipe cut lengths. On each pipe run, the Carrier pipe cut length is equal to the face-to-face distance between Containment fittings. The Containment pipe cut length is equal to the Carrier pipe length plus two (2) Containment pipe socket lengths.
- Termination Fittings are a special configuration for starting or stopping the containment portion of a system. Termination fittings will consist of a reducer coupling to accept the Containment pipe that is pre-fabricated to an internal extender coupling for connection to existing carrier system, thereby terminating (start or stop) the secondary containment portion of the system.
- System installation is best accomplished by consecutive assembly from a starting point to the end of the system. In situations where runs of Carrier and Containment system must meet, the Closure Fitting is a special coupling configuration for joining both Carrier and Containment piping. Closure Fittings are frequently used at the end of a system where the final Termination Fitting must connect to a fixed point in the system.

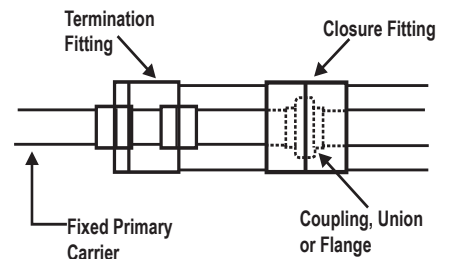
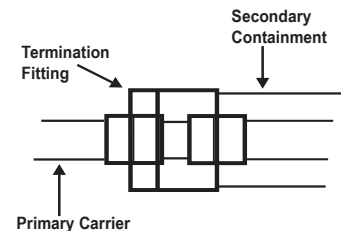
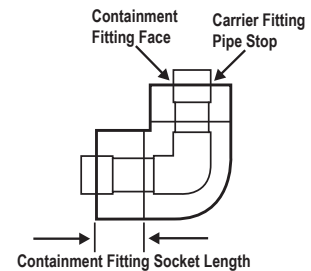
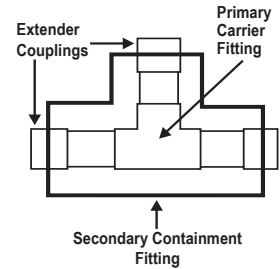



# DOUBLE CONTAINMENT DESIGN & INSTALLATION GUIDE

- Centralizers are a simple slip-on design which are positioned and held in place by a few wraps of Clean-room adhesive on each side. Centralizers hold the Carrier piping centrally located within the Containment piping and are designed with an annular space for routing of leak detection cable, if used.

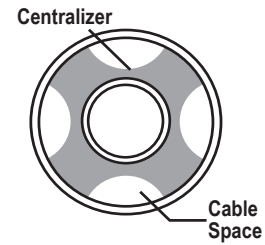

- In-Line Ball Valve Boxes are a pre-assembled “Tee-style” configuration with a valve installed for connection to Carrier and Containment piping. A threaded access is provided through the tee-box branch. Valve handle extensions through the cap are available as an option.

**NOTE:** Tee-style valve boxes are normally over specified containment pipe size and bushed down in order to accommodate carrier valve.

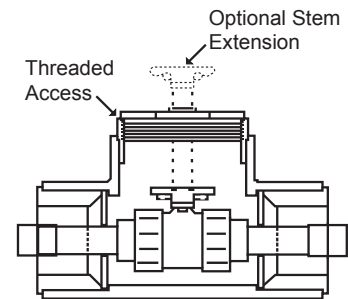

- Sensor Saddles are special devices which can be installed on the Containment system where a “low-point” is desired for leak-detection apparatus. Saddles may also be used in Containment piping high points for air relief or for connection of Containment drainage valves.

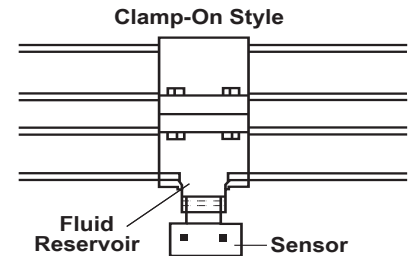

- Expansion Joints are designed to accommodate linear thermal expansion and contraction in thermoplastic systems using an O-ring sealed internal piston. These units can be used on either primary Carrier or secondary Containment portions of the system, especially where a significant temperature differential exists between the two. Expansion Joints also double as an adjustable coupling or repair coupling for making pipe connections.

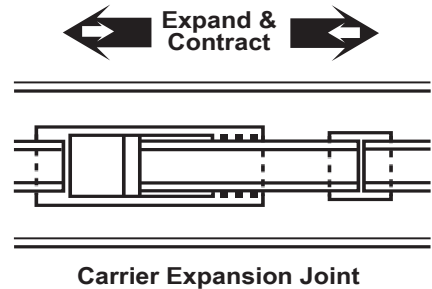

- Additional specialty configurations can be custom produced according to user requirements.

### III. PRODUCT RECEIVED

Carrier and Containment pipe are sold and shipped separate from each other in standard stock 20-foot lengths. Finished cut lengths are prepared by the user at time of installation.

Likewise, each configuration of a double containment fitting is shipped with Carrier and Containment fittings separately, except special configurations that require factory pre-assembly. Upon receipt, each double containment configuration (Carrier fitting and Containment fitting) should be matched up in preparation for installation

**NOTE: ASSEMBLED CARRIER/CONTAINMENT PIPE AVAILABLE ON REQUEST.**

# DOUBLE CONTAINMENT DESIGN & INSTALLATION GUIDE



## IV. GENERAL INSTALLATION ASSEMBLY

**Important:** Proper solvent cementing procedures must be followed. See Appendix A

### Termination Fitting - The Proper Starting Point

Where practical, it is easiest to start using a Termination fitting. This special fitting terminates (start/stop) the secondary Containment portion of the system. The Termination fitting is assembled to the existing primary piping system which continues as the Carrier in the double containment portion of the system and provides a connection for starting (or ending) the Containment piping.

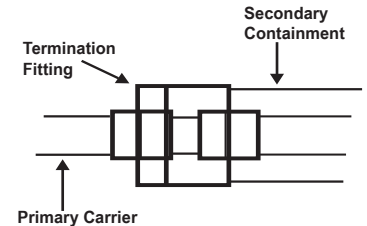

### Step 1: Install Termination Fitting to Primary Carrier Pipe

Using proper dauber size, cement Termination Fitting to the primary carrier piping.

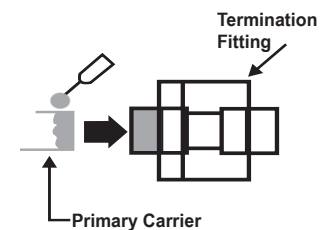

### Step 2: Cut Carrier & Containment Pipe Lengths

**Important:** All pipe MUST be cut square and properly deburred and beveled.

1. **Carrier Pipe Cut Length:** Determine the distance between the Containment socket end face of the first fitting to the socket end face of the next Containment fitting and cut Carrier pipe to that length.

**Note:** This dimension can be calculated from system centerlines as follows:

$$L_{car} = D - (C1 + C2)$$

Where:  $L_{car}$  = Carrier Pipe Cut Length  
 $D$  = Centerline to Centerline distance between Containment fittings  
 $C1$  = Centerline to socket end of first Containment fitting  
 $C2$  = Centerline to socket end of second Containment fitting

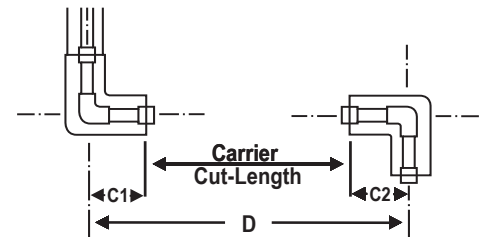

2. **Containment Pipe Cut Length:** Add the socket lengths for each of the two (2) connecting Containment fittings to the Carrier pipe cut length and cut the Containment pipe to that length.

**Note:** This dimension can be calculated as follows:

$$L_{con} = L_{car} + S1 + S2$$

Where:  $L_{con}$  = Containment Pipe Cut Length  
 $L_{car}$  = Carrier Pipe Cut Length  
 $S1$  = Socket Length of first Containment fitting  
 $S2$  = Socket Length of second Containment fitting

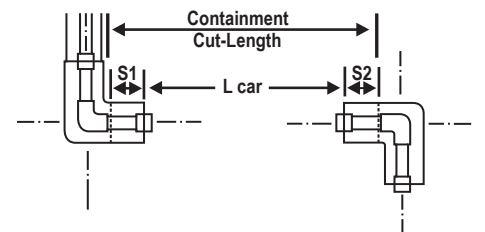

**COUPLING NOTE:** Regular couplings do not come with extenders. Where a continuation of a straight pipe run is made with a coupling on carrier or containment pipe, use the overall coupled length in the above calculations. Special allowances should also be made for Closure Fittings and Expansion Joints in determining cut lengths.



# DOUBLE CONTAINMENT DESIGN & INSTALLATION GUIDE

### Step 3: Assemble Slip-On Centralizers

The chart below shows recommended Centralizer support spacing according to Carrier pipe size, material and Schedule at specified operating temperature for liquids up to 1.00 specific gravity, but does not include concentrated loads. (See chart note on double containment system support.)

### RECOMMENDED MINIMUM CENTRALIZER SUPPORT SPACING (ft.) \*

Carrier Size (in.)	PVC SCHEDULE 40 CARRIER Temperature °F					PVC SCHEDULE 80 CARRIER Temperature °F					CPVC SCHEDULE 80 CARRIER Temperature °F					
	60°	80°	100°	120°	140°	60°	80°	100°	120°	140°	73°	100°	120°	140°	160°	180°
1/2	4-1/2	4-1/2	4	2-1/2	2-1/2	5	4-1/2	4-1/2	3	2-1/2	5-1/2	5	4-1/2	4-1/2	3	2-1/2
3/4	5	4-1/2	4	2-1/2	2-1/2	5-1/2	5	4-1/2	3	2-1/2	5-1/2	5-1/2	5	4-1/2	3	2-1/2
1	5-1/2	5	4-1/2	3	2-1/2	6	5-1/2	5	3-1/2	3	6	6	5-1/2	5	3-1/2	3
1-1/2	6	5-1/2	5	3-1/2	3	6-1/2	6	5-1/2	3-1/2	3-1/2	7	6-1/2	6	5-1/2	3-1/2	3-1/2
2	6	5-1/2	5	3-1/2	3	7	6-1/2	6	4	3-1/2	7	7	6-1/2	6	4	3-1/2
3	7	7	6	4	3-1/2	8	7-1/2	7	4-1/2	4	8	8	7-1/2	7	4-1/2	4
4	7-1/2	7	6-1/2	4-1/2	4	9	8-1/2	7-1/2	5	4-1/2	9	8-1/2	8	7-1/2	5	4-1/2
6	8-1/2	8	7-1/2	5	4-1/2	10	9-1/2	9	6	5	10	9-1/2	9	8	5-1/2	5
8	9	8-1/2	8	5	4-1/2	11	10-1/2	9-1/2	6-1/2	5-1/2	11	10-1/2	10	9	6	5-1/2
10	10	9	8-1/2	5-1/2	5	12	11	10	7	6	11-1/2	11	10-1/2	9-1/2	6-1/2	6
12	11-1/2	10-1/2	9-1/2	6-1/2	5-1/2	13	12	10-1/2	7-1/2	6-1/2	12-1/2	12	11-1/2	10-1/2	7-1/2	6-1/2

**Note:** Specified minimum spacing can also be used for system support according to the secondary Containment pipe size and Schedule used. Where practical, system support should correspond to internal Carrier support (Centralizers) to minimize concentrated point loads.

\* **Note:** Data furnished is based on raw material manufacturer's information. This information can be considered a reliable recommendation, but not a guarantee. Actual service conditions and system parameters should be evaluated by qualified personnel.

Assemble Centralizers to Carrier pipe as required, (see chart above) holding in place with a loop of Clean-room adhesive over one flat side of each Centralizer followed by 3-wraps of adhesive around Carrier pipe on each side of Centralizer to hold loop. Orient so that the flat sides of all Centralizers align. On horizontal runs, the flat side should also lay parallel to the ground to accommodate any sensor wire used.

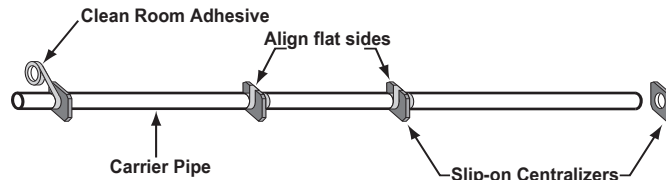
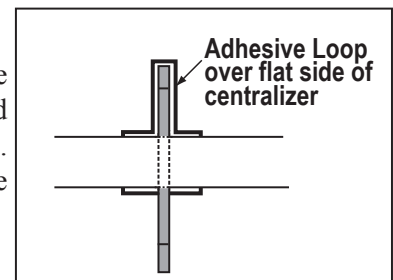

### Step 4: Assemble Carrier Pipe Run Into Containment Pipe Run

Insert Carrier pipe run with Centralizers into Containment pipe run while feeding sensor wire through and under Centralizers as required.

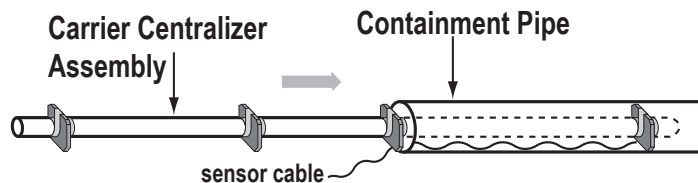



# DOUBLE CONTAINMENT DESIGN & INSTALLATION GUIDE



## Step 5: Solvent Cement Start of Carrier & Containment Run

Position double containment pipe assembly and pull Carrier pipe out enough to allow joint make-up. Using proper dauber size, cement Carrier pipe to first Carrier (or Termination) fitting being sure to properly orient Centralizers. Using a different size dauber if necessary, cement Containment pipe and slide into first Containment (or Termination) fitting.

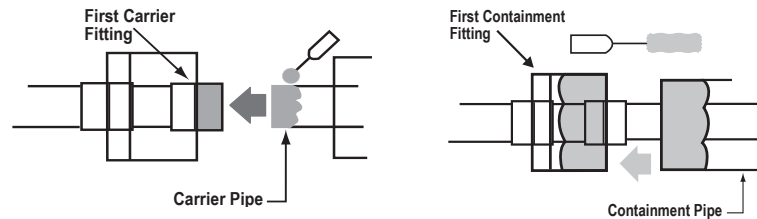

## Step 6: Solvent Cement Next Carrier & Containment Run

At the opposite end of the run, install the next carrier and containment fitting assembly. **Important Note:** Certain carrier x containment sizes and configurations (such as elbows) may require cementing and installation of both fittings at the same time. A dry fit check of both fittings should be made to verify that there is clearance to slide the Containment fitting over the Carrier fitting once the Carrier fitting has been cemented to the carrier pipe. In such cases, slide the Containment fitting back as much as possible and apply cement to both Carrier pipe and extender coupling and to both Containment pipe and Containment fitting using appropriate size daubers. Immediately assemble next Carrier fitting to Carrier pipe and Containment fitting to Containment pipe being sure to align properly.

**NOTE:** This process must be done quickly to prevent cement from drying out before assembly.

Other size and configuration combinations allow Containment fitting to be installed after Carrier fitting is in place. In such cases, slide Containment fitting away from Carrier fitting and cement Carrier pipe to next Carrier fitting, using proper dauber size. Slide next Containment fitting back over Carrier assembly and cement Containment pipe to next Containment fitting, using a different size dauber if necessary. For tees or crosses, where possible, always cement the run double containment assembly before the branch.

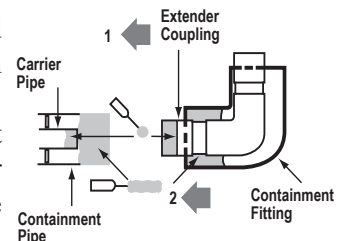

**Important Note:** Some Tees are shipped with the Carrier Tee branch socket extension separated from the Carrier Tee assembly to allow easy movement of the Carrier fitting to facilitate assembly, as shown below. The Carrier Tee branch extension must be **cemented in place** after the run Carrier Tee assembly is completed.

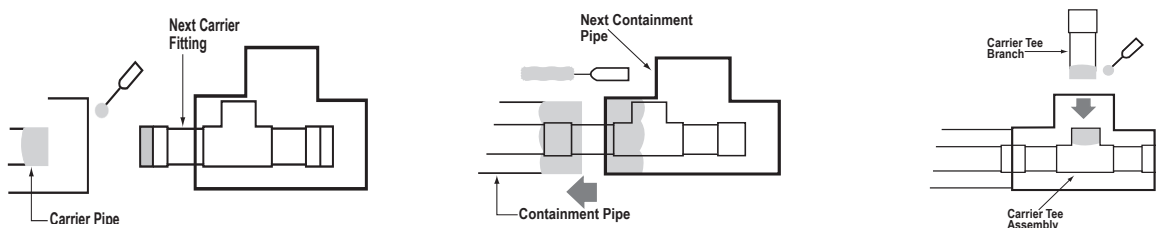

**Repeat Step 2 through 6** above to consecutively assemble each additional section of the Double Containment System. Finish with installation of an additional Termination Fitting. See following instructions on Closure Fittings or on Expansion Joints for joining Double Containment system sections which must meet.



# DOUBLE CONTAINMENT DESIGN & INSTALLATION GUIDE

## V. SPECIAL CLOSURE FITTING INSTALLATION

A Closure Fitting is a special coupling configuration for joining both Carrier and Containment piping in situations where opposing runs of Carrier and Containment system must meet. Closure Fittings are frequently used at the end of a system where the final Termination Fitting must connect to a fixed point in the system. Spears® offer the (2) types of Closure fittings, a solvent cemented closure and a mechanical union closure..

**Spears® Solvent Cement Closure Fittings** consists of 1 male component and 1 female component. An internal O-ring on each component serves as a “cement-wiper” during installation to assure a proper joint. A “One-step” type cement should be used to facilitate rapid assembly.

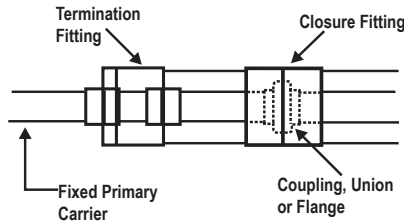

### Typical Closure Fitting Use

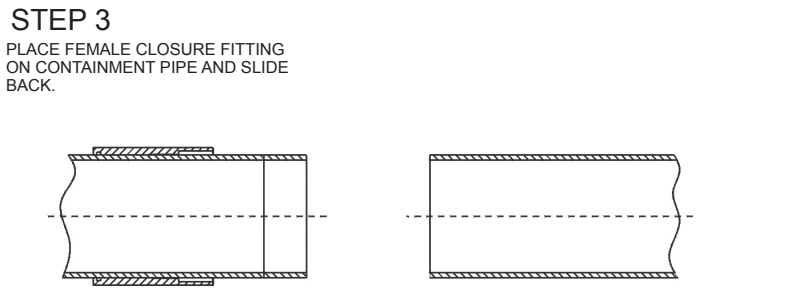
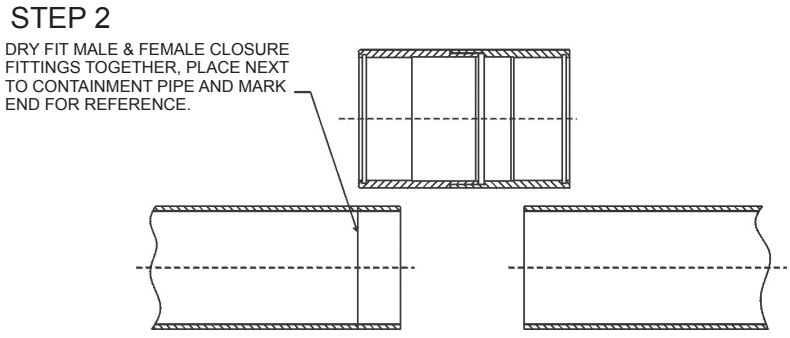
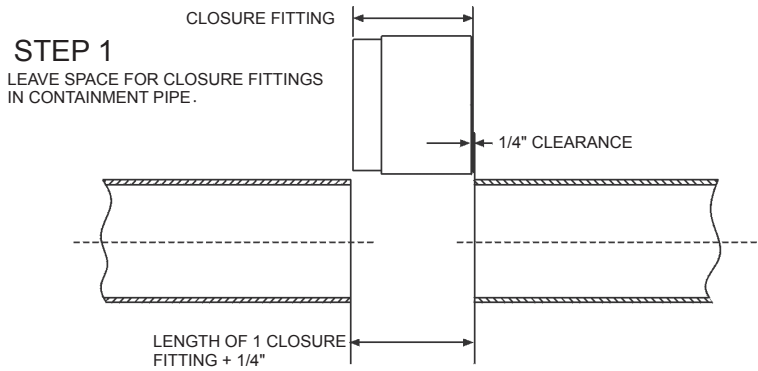



# DOUBLE CONTAINMENT DESIGN & INSTALLATION GUIDE



## STEP 4

PLACE MALE CLOSURE FITTING  
ON CONTAINMENT PIPE AND SLIDE  
BACK.

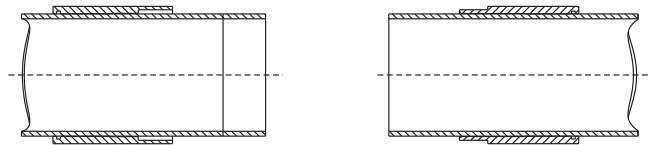

## STEP 5

COMPLETE CARRIER PIPE. IF SUFFICIENT  
MOVEMENT FOR A SOCKET JOINT CANNOT  
BE MADE, A UNION, FLANGE OR EXPANSION  
JOINT MAY BE REQUIRED.

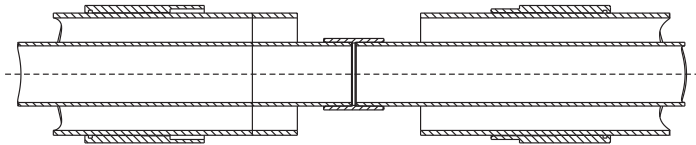

## STEP 6

USE ONE-STEP CEMENT ON FEMALE  
CONTAINMENT PIPE. APPLY WELL PAST  
MARK ON PIPE. O-RING WILL WIPE OFF  
EXCESS. SLIDE CLOSURE FITTING FORWARD  
TO MARK ON PIPE MADE IN (STEP 2)  
LET CEMENT CURE BEFORE CONTINUING TO  
NEXT STEP.

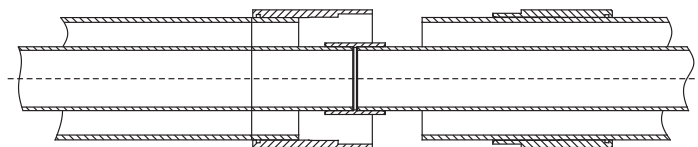

## STEP 7

USE ONE-STEP CEMENT ON CONTAINMENT  
PIPE. APPLY WELL PAST WHERE THE END  
OF CLOSURE FITTING WILL BE INSTALLED.  
ALSO CEMENT MALE PORTION OF CLOSURE  
FITTING AND INSIDE THE MATING FEMALE JOINT.  
SLIDE MALE FITTING INTO FEMALE FITTING AND  
CLAMP WITH A BAR OR PIPE-TYPE CLAMP.

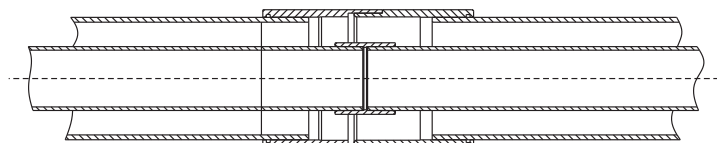



# DOUBLE CONTAINMENT DESIGN & INSTALLATION GUIDE

**Spears® Union Closure Fittings** consists of 1 male component and 1 female component joined by a Union Nut for easy future access to the containment interior. Union Closure Fittings also provide a small amount of expansion and contraction.

**Spears® Double Containment Union Closure Fittings also provide a small amount of expansion and contraction.**

**Maximum 100 PSI Short Term Hydrostatic Test Only. 50 psi Working Pressure @73°F (23°C).**

## Spears® Double Containment Union Closure Fitting

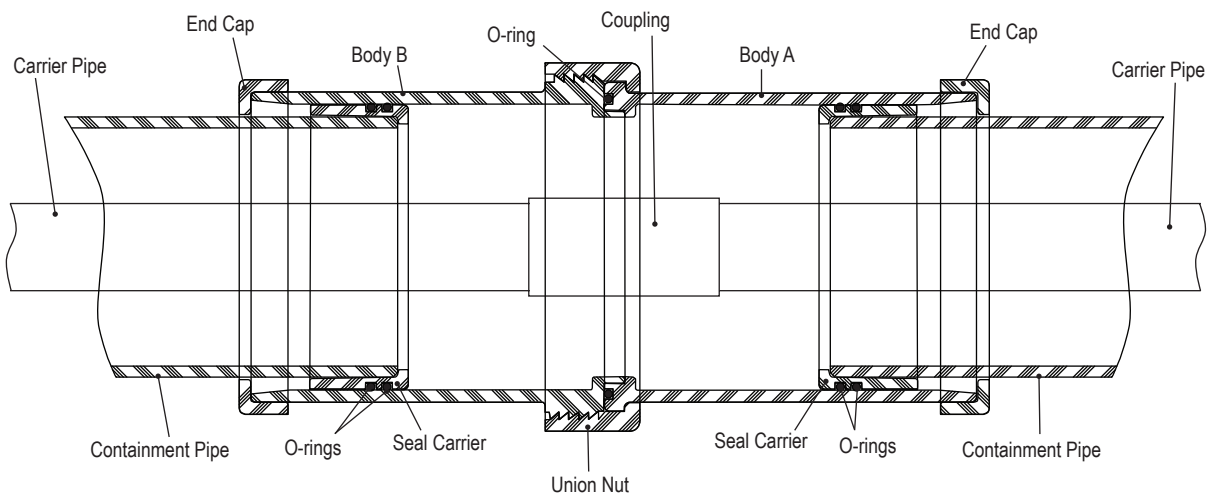

**STEP 1** Leave space for Closure Fittings in containment pipe.

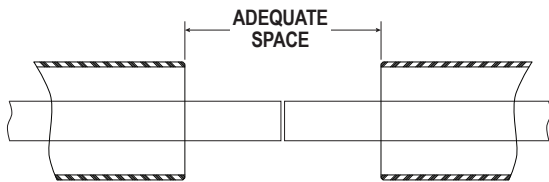

**STEP 2** Slide End Caps onto containment pipe facing the proper direction.

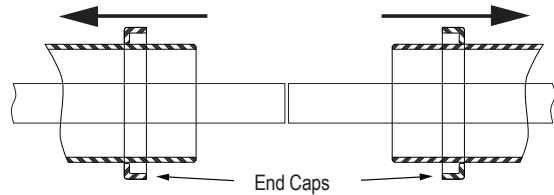

**STEP 3** Install Seal Carriers.

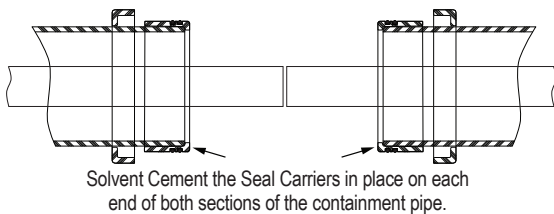

**STEP 4** Install Union Nut and apply supplied silicone to O-rings.

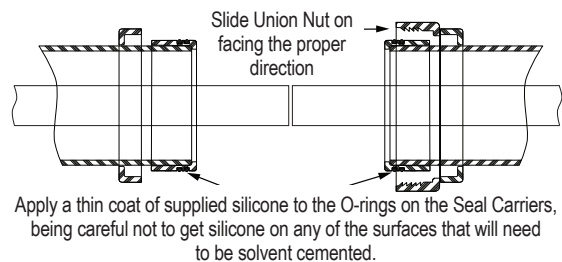

# DOUBLE CONTAINMENT DESIGN & INSTALLATION GUIDE



STEP 5 Install Body A to the same side Union Nut is on. Install Body B to other side.

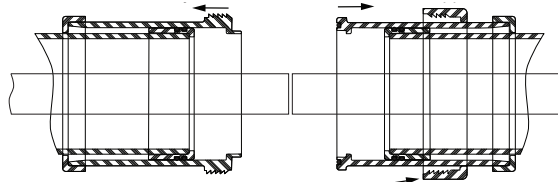

MAKE SURE TO HAVE THE UNION NUT INSTALLED ON THE CORRECT BODY HALF.

STEP 6 Complete Carrier Pipe. If sufficient movement for a socket joint cannot be made, a Union, Flange or Expansion Joint may be required.

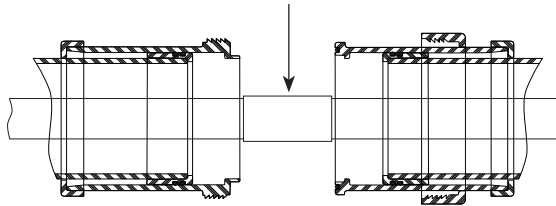

STEP 7 Slide Body Halves together.

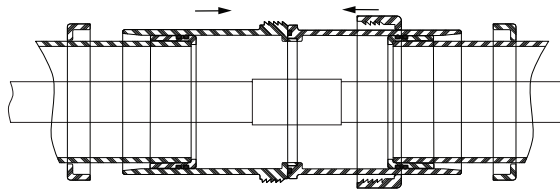

STEP 8 Tighten Union Nut.

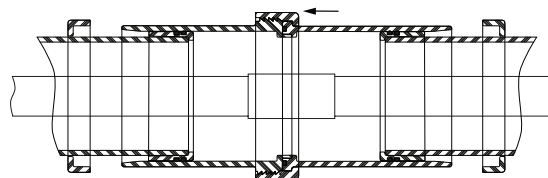

STEP 9 Solvent Cement End Caps into place. End caps restrain movement and prevent body from sliding off seal carriers.

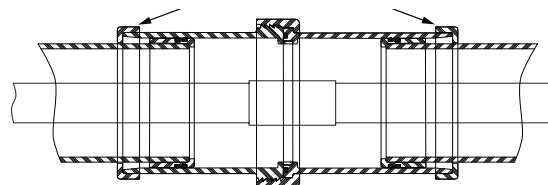

Installation is complete.



# DOUBLE CONTAINMENT DESIGN & INSTALLATION GUIDE

## VI. ISOLATION COUPLER INSTALLATION

The purpose of the Isolation Coupler is to isolate a containment section for improved location identification if a leak is detected. To accomplish this, the Isolation Coupler has a partition in the Containment section fixed to the Carrier section.

### Step 1: Solvent Cement Isolation Coupler on Carrier and Containment Pipe Run

This coupler requires cementing of both primary Carrier and Containment joints at the same time. Using the right size dauber, cement both sockets on one end of the Isolation Coupler and both pipe ends of the Carrier and Containment pipe run. Assemble both joints immediately. **Note:** This process must be done quickly to prevent cement from drying out before assembly

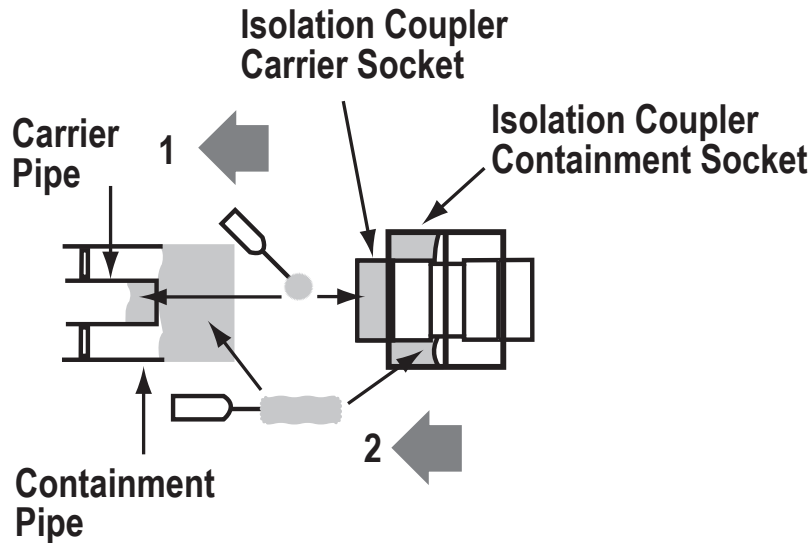

### Step 2: Solvent Cement Start of Next Carrier & Containment Run

Position the next double containment pipe and centralizer assembly and pull Carrier pipe out enough to allow joint make-up. Using proper dauber size, cement Carrier pipe to Carrier socket of Isolation Coupler being sure to properly orient Centralizers. Using a different size dauber if necessary, cement Containment pipe and slide into Containment socket of the Isolation Coupler

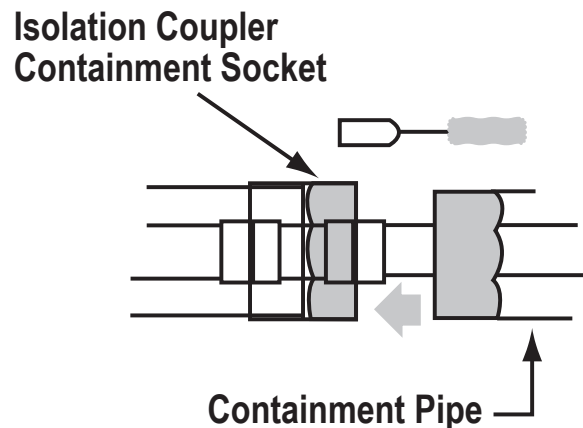
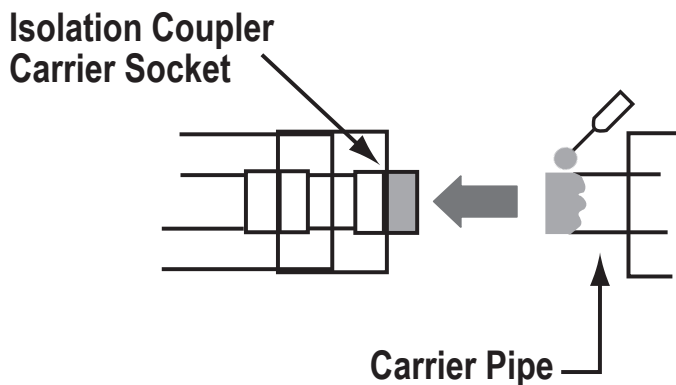

# DOUBLE CONTAINMENT DESIGN & INSTALLATION GUIDE



## VII. IN-LINE VALVE BOX INSTALLATION

Tee-style valve boxes come with Spears® True Union 2000 style ball valves or ball check valves installed. Centralizers are pre-installed in box to give support to the valve. In-Line Valve Boxes are constructed in a larger diameter than the secondary containment system in order to accommodate the appropriate valve for the carrier system. These are fitted with reducers for connection to the containment system. Valve boxes can be ordered with stem extensions for exterior operation of valve. Ball and Ball Check Valves are available for use with Carrier pipe sizes 1/2" through 4", PVC or CPVC using EPDM or FKM seals. Other valve types available on request.

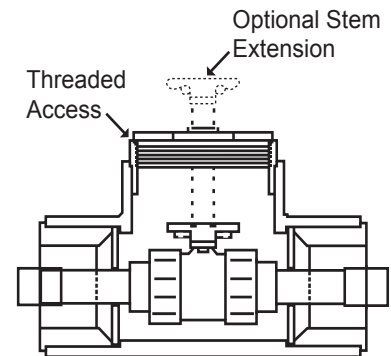

Using appropriate size daubers, apply cement to both Carrier pipe and extender coupling and to both Containment pipe and Valve Box Containment enclosure. Assemble immediately being sure to apply pressure to the opposite end extender coupling to seat Carrier connection.

**Note:** This process must be done quickly to prevent cement from drying out before assembly. A one-step type cement is recommended for this installation.

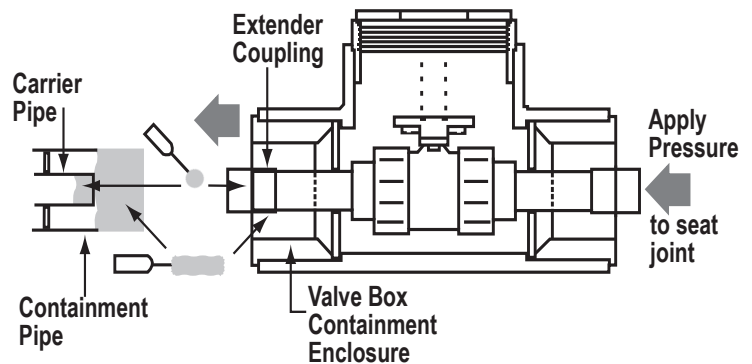

## VIII. EXPANSION JOINT INSTALLATION

Expansion Joints can be used to compensate for linear thermal expansion in Carrier or Containment portions of the system. Expansion Joints are available in either 6" or 12" extension lengths.

### Step 1: Determine Travel Length Needed

**General Rule:** For PVC systems, allow 3/8" expansion for every 10°F change in temperature per 100 feet of pipe (all diameters). For CPVC systems, allow 1/2" expansion for every 10°F change in temperature per 100 feet of pipe (all diameters). For example, a 6" travel expansion joint will accommodate approximately 160°F temperature change in 100 ft. of PVC pipe ( $16 \times 3/8" = 6"$ ) or approximately 120°F temperature change in 100 ft. of CPVC pipe ( $12 \times 1/2" = 6"$ ).

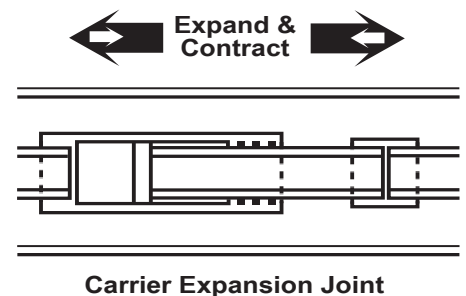



# DOUBLE CONTAINMENT DESIGN & INSTALLATION GUIDE

## Step 2: Support & Thrust Block

**ON SECONDARY CONTAINMENT PIPING:** For proper operation, the outer tube of the Expansion Joint should be firmly anchored to allow free movement of the inner tube or “piston.” Alignment is critical. Support and thrust block the system to direct movement squarely into the Expansion Joint. Alignment is critical and axial guides should be installed to ensure straight movement into Expansion Joint. Provisions should be made to protect the cylinder shaft from scratches, damage and debris in order to prevent leaks.

**ON PRIMARY CARRIER PIPING:** A Centralizer bracket should be located at each end of the Expansion Joint to serve as an axial guide to ensure straight movement into Expansion Joint. Protect the cylinder shaft from scratches, damage and debris during installation.

## Step 3: Install Expansion Joint in Line

Determine installed extension length and solvent cement unit in system. Expansion Joints can be installed at the travel range midpoint for most general installations and are shipped from the factory in this position. If desired, the extended position for installation may be additionally adjusted to specific system and installation parameters using the following calculation:

T-A	T = Maximum Temperature of Pipe Exposure
----- × E = P	A = Temperature of Pipe at time of Installation
T-F	E = Maximum Expansion Joint Travel (6" or 12")
	P = Piston Extension for Installation Position (inches)
	F = Minimum Temperature of Pipe Exposure

Example: A straight run of pipe will operate at temperatures between 60°F and 110°F. Temperature at time of installation is 75°F using a 6" travel Expansion Joint.

T-A	110-75
----- × E = P	----- × 6 = 4.2 inches extended at installation
T-F	110-60

### Supplemental Information Notes:

Maximum operating temperature:	PVC = 140°F
	CPVC = 180°F
Coefficient of Linear Thermal Expansion:	PVC 1120 = 2.8 x 10 <sup>-5</sup> in/in/°F
	CPVC 4120 = 3.4 x 10 <sup>-5</sup> in/in/°F

# DOUBLE CONTAINMENT DESIGN & INSTALLATION GUIDE



## XI. SENSOR SADDLE INSTALLATION

PVC and CPVC Sensor Saddles are available in Clamp-On type with O-ring seal for Containment pipe sizes 2" through 6" or in Glue-On style for Containment pipe sizes 1/2" and larger. Specify branch outlet size in thread or socket connection. Sensor Saddles should be installed in a low point along a Containment pipe run for collection of any fluid leakage. Install user-supplied sensor device. Saddles may also be used in Containment piping high points for air relief or for connection of Containment drainage valves.

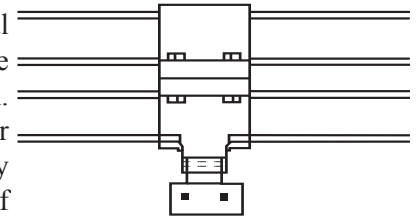

Clamp-On Style Sensor Saddle

### Clamp-On Style Saddle Installation

1. Using a standard industrial-grade hole saw, cut specified hole in desired position on pipe according to recommended hole saw size engraved on saddle. **Note:** Care must be taken to deburr hole and remove all residue from hole area to assure tight fit and avoid leakage.
2. Fully seat O-ring in groove on underside of saddle outlet component. Position over hole and fully seat saddle onto pipe. **Note:** Saddle outlets are piloted. Be sure pilot lip fully engages with hole in pipe.
3. Place strap component opposite outlet and secure with bolts (4), nuts (4), and washers (8). Washers **MUST** be placed under each bolt head and nut to avoid damage to saddle.
4. Tighten bolts to specified torque.
5. Saddle is now ready for user-supplied sensor device installation.

### Glue-On Style Saddle Installation

1. Using a standard industrial-grade hole saw, cut specified hole in desired position on pipe according to recommended hole saw size. **Note:** Care must be taken to deburr hole and remove all residue from hole and cement area to assure proper fit.
2. Dry fit saddle over hole and mark perimeter on pipe.
3. Clean pipe and saddle glue surface, apply solvent cement to saddle and to pipe, fully covering marked area.
4. Immediately press saddle onto pipe while rotating the saddle on the pipe slightly to distribute the cement. Secure each end of saddle with gear-type clamp or strap to maintain compression until solvent cement fully cures.
5. Saddle is now ready for user-supplied sensor device installation.

## X. PRESSURE TESTING SYSTEM

After all joints have properly cured, the Secondary Containment system may be air tested at 5 to 8 psig regulated pressure. **WARNING: System must NOT be tested with direct connection of air-line, nitrogen bottle, or similar unregulated pressure device. Test apparatus must be equipped with both a pressure limiting device at the source to assure that 8 psig pressure is not exceeded and an air relief device at the far end of the system is set at a maximum pressure of 8 psig. FAILURE TO FOLLOW THIS PROCEDURE CAN RESULT IN SERIOUS OR FATAL BODILY INJURY.** Use a spray bottle of soap and water solution to check for leaks at joints. The Primary Carrier system should be hydrostatically tested. Flush the system to remove any debris and slowly fill to remove all entrapped air.





# DOUBLE CONTAINMENT DESIGN & INSTALLATION GUIDE

## Appendix A: General Solvent Cement Welding Procedures

For best results, installation should be made at temperatures between 40°F and 110°F. All joint components should be inspected for any breaking, chipping, gouging or other visible damage before proceeding. All pipe, fittings and valves should be removed from packaging or containers and exposed to the installation environment for a minimum of one hour in order to thermally balance all components. All joining components must be clean and dry.

**Important:** TAKE EXTRA CARE THAT NO PRIMER OR SOLVENT CEMENT IS ALLOWED TO COME IN CONTACT WITH THE BALL OR OTHER INTERNAL COMPONENTS OF VALVES, EXPANSION JOINTS, OR UNIONS.

### Step 1: Cut Pipe Square

Pipe ends must be cut square, using a wheel-type cutter or saw & miter box. A fine-toothed hand saw (16-18 teeth/inch) with little or no set is recommended. A power cut-off saw with carbide blade is recommended for high volume cutting.

### Step 2: Deburr & Bevel Pipe

Regardless of cutting method used in Step 1, burrs are created which must be removed from both the pipe I.D. and O.D. before joining. All pipe ends should be beveled 10° to 15°. Commercially available deburring & beveling tool is recommended, or a mill file may be used.

### Step 3: Clean Joint Components

Wipe away all loose dirt and moisture from the pipe O.D. and fitting I.D. with a clean, dry cotton rag. DO NOT ATTEMPT TO JOIN WET SURFACES.

### Step 4: Check Joint Interference Fit

An interference between pipe and fitting socket is necessary for proper fusion of the joint. To check, lightly insert pipe into fitting socket. **DO NOT FORCE**. Interference between pipe and fitting must occur between ½ of the socket depth (full interference fit) and the socket bottom (net fit). Do not use components which improperly mate.

### Step 5: Apply Primer

**NOTE:** Certain Double Containment solvent cement connections should be made using a “one-step” type cement specifically designed for use without primer. Go to Step 6 if using a one-step type of solvent cement.

Primer is necessary to penetrate and soften both pipe and fitting socket surfaces in order for the solvent cement to properly bond. **THE MOST FREQUENT CAUSE OF JOINT FAILURES IS INADEQUATE SOLVENT PENETRATION AND SOFTENING OF BONDING SURFACES DURING THE WELDING OPERATION.**

1. Using a brush or applicator size not less than ½ the pipe diameter, apply a liberal coat of primer with a scrubbing motion to the fitting socket until the surface is softened and semi-fluid. This may take 5 to 15 seconds depending on size and temperature. (Larger diameters and lower temperatures will increase required time.)
2. Apply primer to pipe in the same manner, extending application area to slightly more than the insertion depth into the fitting socket.
3. Apply a second coat to both the fitting socket and the pipe.
4. Check penetration and softening by scraping the primed surfaces. A few thousandths of the semi-fluid surface should be easily removed. Repeat primer application if necessary.

# **DOUBLE CONTAINMENT DESIGN & INSTALLATION GUIDE**



## **Step 6: Apply Solvent Cement**

Solvent cement must be applied IMMEDIATELY to primed surfaces before the primer dries, in an alternating 3-coat application. Using a brush or applicator size no less than ½ the pipe diameter, apply a liberal coat of solvent cement to the primed pipe surface, then apply a light to medium coat to the primed fitting socket. If a "net fit" was experienced during dry fit check (Step 4), apply an additional coat again to the pipe surface. BE SURE TO USE A VERY LIBERAL AMOUNT OF SOLVENT CEMENT ON PIPE.

## **Step 7: Join Components**

IMMEDIATELY following application of cement and before it starts to set, insert the pipe into the socket with a 1/4-turn twisting motion to evenly distribute cement within the joint. A full bead of cement should form around the circumference of the joint. Hold joint together for approximately 30 seconds to make sure the pipe does not move or back out of the socket.

## **Step 8: Remove Excess Cement**

Using a cloth, wipe clean all excess cement from the exterior juncture of the pipe and fitting.

## **Step 9: Initial Set & Cure Time**

Initial Set & Cure Time must be followed in accordance with the solvent cement manufacturer's instructions.

## **Appendix B: Sample Engineering Specification**

### **1.0 System Design and Manufacturer**

**1.1** Thermoplastic Double Containment System shall be a floating carrier design constructed from conventional pipe and fittings meeting applicable ASTM requirements for all standard configurations of primary carrier and secondary containment. System shall include all pipe, fittings, centralizers, valves and valve boxes to be supplied by Spears® Manufacturing Company.

**1.2** Standard configurations (tees, elbows, crosses, etc.) of primary carrier fitting shall be equipped with extender couplings for installation in secondary containment pipe and fittings.

**1.3** Primary carrier system shall be supported by polypropylene slide-on centralizer brackets positioned with clean room adhesive. Centralizers shall provide annular space suitable for drainage or installation of user-supplied leak detection cable.

**1.4** Specialty fittings shall be according to manufacturer's specifications and suitable for use with specified primary carrier and secondary containment system. Specialty fittings include the following:

Termination Fitting for start and stop of secondary containment.

Closure Fitting for joining two (2) secondary containment lines that meet.

Expansion Joint/Coupling for thermal expansion/contraction compensation or joining of pipe lines.

Sensor Saddles for connection of user-supplied leak detection apparatus.

Any other custom fitting configuration designed for the system.

**1.5** Double Containment System shall be air-vented in the secondary containment to prohibit pressurization in excess of 10 psi.

**1.6** Valve Box enclosure for ball and ball check valves shall be Tee-Style with specified valve installed and optional external stem extension.



# DOUBLE CONTAINMENT DESIGN & INSTALLATION GUIDE

## 2.0 Size & Materials

2.1 Double Containment system shall be primary carrier pipe and fittings (specify size, material & schedule) secondary containment pipe and fittings (specify size, material & schedule \*).

2.2 All primary carrier and secondary containment pipe and fittings shall be manufactured from [specify: PVC, cell class 12454 or CPVC, cell class 23447] materials, according to ASTM D 1784.

2.3 All primary carrier and secondary containment pipe shall meet the requirements of either: ASTM D 1785 for PVC or ASTM F 441 for CPVC.

2.4 All standard configuration primary carrier and secondary containment fittings shall meet the requirements of [specify: ASTM D 2466 for PVC Schedule 40, D 2467 for PVC Schedule 80 or F 439 for Schedule 80 CPVC]. All special configuration fittings shall meet the manufacturer's design requirements and be suitable for use with the designated pipe.

## 3.0 Installation

3.1 Double Containment System shall be installed in accordance with Spears® Double Containment Design & Installation Guide.

3.2 Installation shall be made by qualified personnel trained in making solvent cement joints per ASTM practice D 2855, and flanged joint assembly according to manufacturer's instructions.

3.3 Primary carrier and secondary containment pipe and fitting connections shall be made by conventional solvent cement welding. Flanged assembly connections may be used where required for disassembly or as a design necessity. Solvent cement shall be user supplied and medium to heavy bodied as required. Solvent cement shall be Spears® Low VOC Solvent Cement. Spears® CPVC-24 is recommended for maximum chemical resistance with either PVC or CPVC Piping.

\* See standard size, material and pipe Schedule combinations. Custom size, material and Schedule combinations by request.



## SPEARS® MANUFACTURING COMPANY

### CORPORATE OFFICES

15853 Olden Street, Sylmar, CA 91342  
P.O. Box 9203, Sylmar, CA 91392  
(818) 364-1611 • <http://www.spearsmfg.com>

